

TOPCAT[®]

HIGH-END EFFECTS

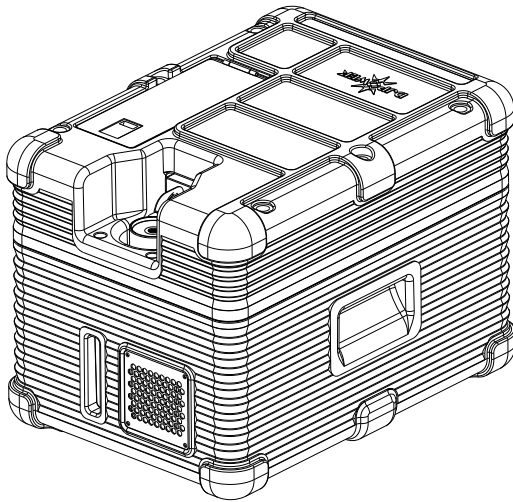

H-4S HAZE MACHINE

USER MANUAL

DJPOWER

1 BEFORE YOU BEGIN

1.1 What Is Included



H-4S Machine × 1 Power Cord × 1 Warranty Card × 1

1.2 Unpacking Instructions

Carefully unpack the product immediately and check the container to make sure all the parts are in the package and are in good condition.

If the box or the contents (the product and included accessories) appear damaged from shipping, or show signs of mishandling, notify the carrier or dealer/seller immediately. In addition, keep the box and contents for inspection.

1.3 Symbols

Symbol	Meaning
	Caution Critical installation, configuration, or operation information. Not following these instructions may make the product not work, cause damage to the product, or cause harm to the operator.
	Important Important installation or configuration information. Failure to comply with this information may keep the product from working correctly.
	Information Useful information.

1.4 Disclaimer

The information and specifications contained in this User Manual are subject to change without notice. DJPOWER assumes no responsibility or liability for any errors or omissions and reserves the right to revise or to create this manual at any time.

Copyright © 2023 DJPOWER. All rights reserved.

1.5 Safety Notes

Please read the following Safety Notes carefully before working with the product. The notes include important safety information about installation, usage, and maintenance.

1.6 Personal Safety

- Always connect the product to a grounded circuit to avoid the risk of electrocution.
- Make sure that children, Unauthorized people and animals do not obtain access to the machine.

1.6.1 Mounting and Rigging

- Place the haze machine horizontally, and check whether it is damaged or not. If damaged, please contact with the supplier at once. Unscrew the lid of tank to add in high-quality haze liquid, and then fasten the lid.
- The product is for indoor and outdoor used! To prevent risk of fire or shock, do not expose the product to rain or moisture.
- Do not use in a confined space. Always install the product in a location with adequate ventilation, at least 12 in (30 cm) from adjacent surfaces.
- Be sure that no ventilation slots on the product's housing are blocked.

1.6.2 Power and Wiring

- Always make sure that the voltage of the outlet to which you are connecting the product is within the range stated on the decal or rear panel of the product.
- Make sure the power cord is not crimped or damaged.
- Never connect this product to a dimmer pack or rheostat.
- Never disconnect the product from power cord by pulling or tugging on the cord.
- To eliminate unnecessary wear and improve its lifespan, during periods of non-use completely disconnect the product from power via breaker or by unplugging it

1.6.3 Operation

- Do not operate this product if you see damage to the housing or cables. Have the damaged parts replaced by an authorized technician at once.
- The maximum ambient temperature (Ta) is 104 °F (40 °C). Do not operate the product at higher temperatures.
- **Do not cover the ventilation slots when operating to avoid internal overheating.**
- **Do not cover or plug the output nozzle during operation.**
- This product contains no user-serviceable parts. Any reference to servicing in this User Manual will only apply to properly trained, certified technicians. Do not open the housing or attempt any repairs which can lead to damage or malfunction.

 **Keep this User Manual for future use. If you sell the product, be sure that the purchaser receives this document.**

2 INTRODUCTION

2.1 Description

H-4S is a oil-based haze machine. Using high-pressure atomization technology, no heating system, to produce haze without for pro-heat up. The housing is made of high-strength composite material, one-time molding, no rust, lighter weight and more durable. Updated nozzle provides better haze effect. Dry and delicate haze and good air retention, suit for all kinds of indoor and outdoor performances.

2.2 Features

- Integration in a stackable flight case makes the DMX hazer tough, durable and easy to carry

- Low-noise operation without air compressor ideal for theater and stage applications
- Produces fine, translucent haze without nebulizing the room at the same time
- Ideal for accentuating light and laser beams
- Fog output and fan speed variably adjustable via rotary controls
- DMX interface with 3-pin connectors
- DMX settings via control panel with LED display
- Temperature control via thermo switch
- Removable tank
- Low fluid sensor
- Operates on standard water based fluid

2.3 Product Overview

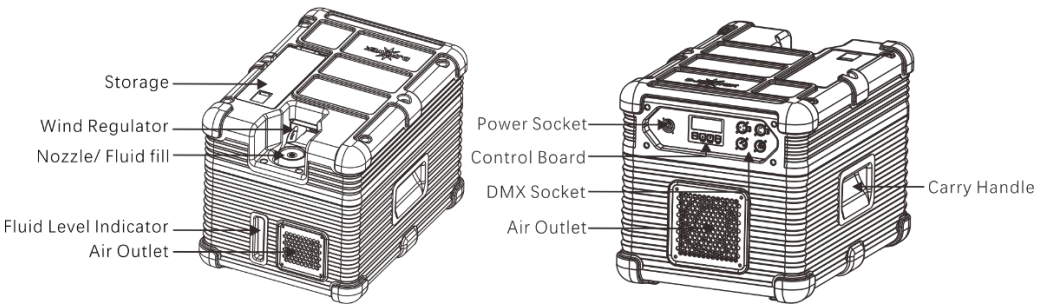

2.4 Product Dimensions

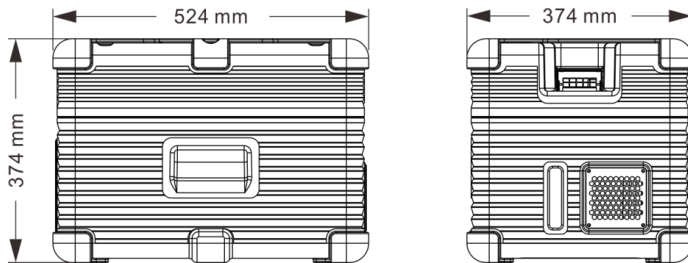

3 TECHNICAL SPECIFICATIONS

AC Power	Input Voltage & Rate	AC 220-240 V, 50/60 Hz
	Power Consumption	550W
Output	Max Output Volume	Appr. 3,200 cuft/min
	Output Volume	Appr. 200 m ³ (5 min suffuse)
	Fluid consumption	Appr.25 h/L
IP Rate	IP Rate	IPX1

Control	Control Protocol	DMX-512
	DMX Channel	2
Capacity	Tank Capacity	2.5 L
	Net Weight	31 kg
Weight & Dimensions	Gross Weight	32.5 kg
	Machine Dimensions	524 × 374 × 371 mm
	Packing Dimensions	612 × 462 × 465 mm
Consumable	Consumable	PRO-H1L

4 SETUP

4.1 AC Power

The machine has a fixed voltage power supply and can work with an input voltage of AC 220 V-240 V, 50/60 Hz, depending on the specific model.

To determine the product's power requirements (circuit breaker, power outlet, and wiring), use the current value listed on the label affixed to the product's back panel, or refer to the product's specifications chart. The listed current rating indicates the product's average current draw under normal conditions.



Always connect the product to a protected circuit (circuit breaker or fuse). Make sure the product has an appropriate electrical ground to avoid the risk of electrocution or fire.



Never connect the product to a rheostat (variable resistor) or dimmer circuit, even if the rheostat or dimmer channel serves only as a 0 to 100% switch.

4.2 DMX Linking

You can link the to a DMX controller using a 3- or 5-pin DMX connection. If using other DMX-compatible products with this product, you can control each individually with a single DMX controller. Instructions for connecting and configuring this product for DMX operation are in the User Manual.

4.3 Mounting

Before mounting the product, read and follow the safety recommendations indicated in the Safety Notes.

4.3.1 Orientation

Always mount this product in a safe position and make sure there is adequate room for ventilation, configuration, and maintenance.

4.3.2 Rigging

DJPOWER recommends using the following general guidelines when mounting this product.

- Before deciding on a location for the product, make sure there is easy access to the product for maintenance and programming purposes.
- Make sure that the structure or surface onto which you are mounting the product can support the product's weight (see the Technical Specifications).

5 OPERATION

5.1 On-device Control Mode & Operation

5.1.1 On-device Control Panel

To access the control panel functions, use the four buttons located underneath the LCD display.

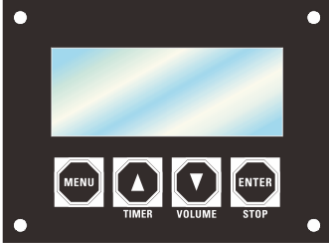

Button	Function
<MENU>	Switch menu pages to select a function
<▲>	Increases the numeric value of current function Triggers Timer output mode
<▼>	Decreases the numeric value of current function Triggers Manual output mode.
<ENTER>	Save settings STOP turns the fog output off

- Refer to the Menu Map to understand the menu options. The menu map shows the main level and a variable number of programming levels for each option.
- To go to the desired main level, press <MENU> repeatedly until the option shows on the display. This will take you to the first programming level for that option.
- To select an option or value within the current programming level, press "▲" or "▼" until the option shows on the display. If there is another programming level, you will see that first option, or you will see the selected value.

5.1.2 Menu Map

	Display	Description	Parameter Range
Preparing Pages	Ready To Fog DJPOWER	Ready to work.	
	Timer Interval 10S	Press "▲" or "▼" to set Timer Interval	5 ~ 200s
Settings Page	Timer Duration 10S	Press "▲" or "▼" to set Timer Duration	5 ~ 200s
	Auto Run Last Settings ON	Press "▲" or "▼" to Auto Run Last Settings	ON/OFF
	Fan Speed 100%	Press "▲" or "▼" to set Fan Speed	1%~100%
	Fluid Level Illuminated ON	Press "▲" or "▼" to set Fluid Level Illuminated	ON/OFF
	Language English	Press "▲" or "▼" to set language, and save it by pressing ENTER	Chinese/English

DMX Address 512

Press "▲" or "▼" to set the DMX starting address 1 ~ 512

Under any setting interfaces, press STOP to exit or return to the first interface.

When the unit is working, press STOP to stop running and return to the first interface.

Press "▲" and "▼" to adjust the value under the setting interface.

On the Preparing Pages, press the "VOLUME" to enter the working Pages.

Working Page	Working DJPOWER	Haze output of VOLUME mode, and you can select it by press "▲" or "▼"
--------------	-----------------	---

Press the button TIMER, to activate the timer mode under first interface. For example, when the display indicates as below:

Working Page	Interval 10S DJPOWER	Interval of TIMER mode	5 ~ 200s
	Duration 10S DJPOWER	Duration of TIMER mode	5 ~ 200s

The unit will spraying fog for 10s and stop for 10s, and repeat. The output volume defaults to the value under "Timer Out" mode.

5.2 DMX Mode & Operation

H-4S can use DMX controller to operate work.

- Connect the machine to a suitable power outlet.
- Turn on the machine.
- Connect the DMX output of the DMX controller to the DMX input socket on the machine via the DMX cable.

After the machine is connected to the DMX signal, the display screen can only display the DMX address setting page. At this time, you can set and modify the DMX512 address by pressing the "▲" or "▼" key.

DMX Mode: DMX Channel

DMX Mode	Channel 1	Working	0-10	OFF
			11-255	ON
	Channel 2	Fan Speed	0-26	One level
			27-52	Two level
			53-78	Three level
			79-104	Four level
			105-130	Five level
			131-156	Six level
			157-182	Seven level
			183-208	Eight level
			209-234	Nine level
			235-255	Ten level

6 MAINTENANCE

1. To maintain the system in good performance and running status, it is recommended to running the device at least once per month.



Test-run your DJPOWER® H-4S on a monthly basis to achieve the best performance.