

**TOPCAT**<sup>®</sup>  
HIGH-END EFFECTS

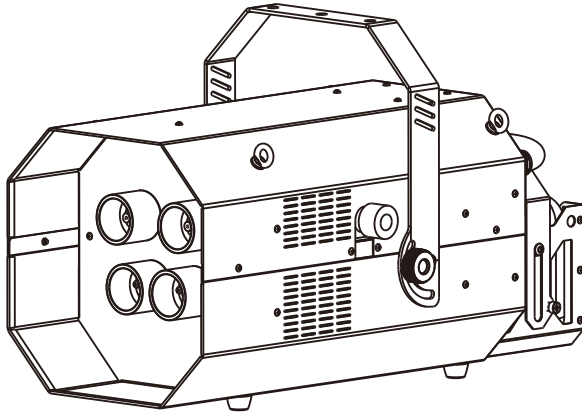

## **X-7M HYBRID JET**

---

### **USE MANUAL**

GUANGZHOU DJPOWER ELECTRONIC TECHNOLOGY CO.,LTD

# 1 BEFORE YOU BEGIN

## 1.1 What Is Included

X-7M Hybrid JET × 1

Power cord × 1

Warranty card × 1



Optional accessory: 2pcs 10m hose and connectors

## 1.2 Unpacking Instructions

Carefully unpack the product immediately and check the container to make sure all the parts are in the package and are in good condition.

If the box or the contents (the product and included accessories) appear damaged from shipping, or show signs of mishandling, notify the carrier or dealer/seller immediately. In addition, keep the box and contents for inspection.

## 1.3 Symbols

Symbol	Meaning
	<b>Caution</b> Critical installation, configuration, or operation information. Not following these instructions may make the product not work, cause damage to the product, or cause harm to the operator.
	<b>Important</b> Important installation or configuration information. Failure to comply with this information may keep the product from working correctly.
	<b>Information</b> Useful information.

## 1.4 Disclaimer

The information and specifications contained in this User Manual are subject to change without notice. DJPOWER assumes no responsibility or liability for any errors or omissions and reserves the right to revise or to create this manual at any time.

Copyright © 2020 DJPOWER. All rights reserved.

## 1.5 Safety Notes

Please read the following Safety Notes carefully before working with the product. The notes include important safety information about installation, usage, and maintenance.

### 1.5.1 Carbon Dioxide (CO<sub>2</sub>)

X-7M can use carbon dioxide. Improper use of carbon dioxide will lead to serious consequences. Before installation or operation, be sure that you have known the hazards of improper use. Please use certified

carbon dioxide cylinders, tubes and connectors. Please consult your suppliers for rules and guidelines for safe installation and use.

DJPOWER shall not be responsible for the dangers, accidents and damage caused by the incorrect use of carbon dioxide and the gas cylinder.



**When using carbon dioxide machines and carbon dioxide cylinders, improper installation or operation can cause serious injury or death. Please follow the user manual or the instructions of the supplier or your local authorized person.**

### 1.5.2 Personal Safety

- Always connect the product to a grounded circuit to avoid the risk of electrocution.
- **Do not spray on people when the machine is working, and keep a distance of at least 4 meters from people.**
- Do not touch the hot nozzle of the machine during operation.
- When hanging this product, make sure that the product and cables are away from people and vehicles.
- Do not use the product as a space heater.
- Do not install the machine on the surface of flammable objects (linoleum, carpet, wood, paper, carton, plastic, etc.)
- Please keep the machine dry. Do not expose the machine to rain or moisture. Do not use the machine when it is wet, wipe with a dry cloth.
- Make sure that children, unauthorized people and animals do not obtain access to the machine.

### 1.5.3 Mounting and Rigging

- Connection sequence: first connect the non-quick connector, then connect the quick connector
- When the machine is working, the gas pressure inside the hose is very high. Please be sure that the connection of the non-quick connectors are firmly tightened with a wrench, otherwise it may cause gas leakage.
- Please pay attention to protect the quick connectors during the connection process to avoid friction and impact between the quick connectors and hard objects (such as the floor). Keep the quick connectors clean, otherwise it may cause gas leakage from the quick connectors.
- After the hose is connected, first test the electrical performance of the machine to ensure that there is no abnormal electrical performance.
- After testing the electrical performance, it is forbidden to approach the front of the nozzle. Please SLOWLY open the valve of the carbon dioxide gas cylinder. Be careful! Do not open the valve completely at once. Listen carefully to check if there is sound of gas leakage while opening. After confirming that there is no gas leakage, fully open the valve.
- If there is leakage from the connectors, immediately close the valve of the gas cylinder, make sure to release the gas in the hose and connectors before reconnecting. If the leakage happens in a non-quick connector, normally it is because the connector is not well tightened and it can be solved by tightening it firmly with a wrench. If the leakage happens in a quick connector, normally it is because the hose is not connected in place. At this moment, please do not reconnect immediately. First disconnect the quick connector, wait till the temperature of the connector is back to normal( it takes at least 10 minutes), and then reconnect the quick connector.

- After the valve of the gas cylinder is fully opened, the pressure gauge shows that the normal value is about 5-7MPa. If the pressure is too low, it indicates that the gas of the cylinder is insufficient.
- In the first use after connection, the jet might not be powerful which is normal because there is air remaining in the hose after first connection.

#### 1.5.4 Other Important Notes

- When the machine is not in use, regularly clean each air inlet and air outlet to prevent sand and dust from clogging, hence extending the service life.
- The maximum service life of the connection hose is 1 year, and new connection hose needs to be replaced after 1 year.

#### 1.5.5 Installation Instructions

- After checking that the machine and accessories are not damaged, if you need to hang the unit, please use the safety rope to securely fix the machine to the truss through the machine hook.
- Connect the machine with two hoses, adjust the direction of the nozzle and lock it, then connect the unit to power through power cord.
- Check out whether your gas cylinder is with siphon tube or not, whether placed on end or horizontally. Wrong usage of the gas cylinder will make the gas light and thin. In case lying horizontally(See picture ), please make the bottom higher than the top by adding a 20cm object under the bottom of the gas cylinder.

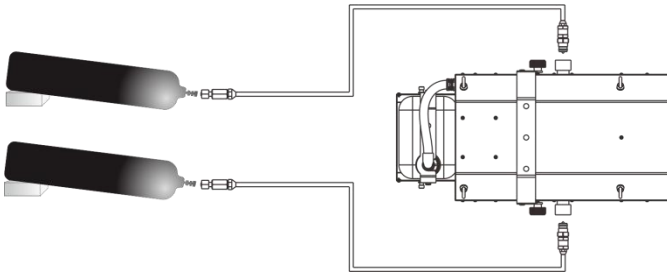

#### 1.5.6 Power and Wiring

- Always make sure that the voltage of the outlet to which you are connecting the product is within the range stated on the decal or rear panel of the product.
- Make sure the power cord is not crimped or damaged.
- Do not connect the machine to the dimming controller or rheostat.
- Never disconnect the product from power cord by pulling or tugging on the cord.
- To eliminate unnecessary wear and improve its lifespan, during periods of non-use completely disconnect the product from power via breaker or by unplugging it.

#### 1.5.7 Operation

- Do not operate this product if you see damage to the housing or cables. Have the damaged parts replaced by an authorized technician at once.
- Never carry the product by the power cord or any moving part. Always use the handles.

- The maximum ambient temperature (Ta) is 104 °F (40 °C). Do not operate the product at higher temperatures.
- Stop using the machine when visibility is less than 50 cm.
- This product contains no user-serviceable parts. Any reference to servicing in this User Manual will only apply to properly trained, certified technicians. Do not open the housing or attempt any repairs which can lead to damage or malfunction.
- In the event of a serious operating problem, stop using the product immediately.



**Please save this manual for future use. When resell the machine, be sure to attach the instructions.**

## 2 INTRODUCTION

### 2.1 Description

X-7M is a latest developed Hybrid Jet by mixing CO2 JET and FOG machine.

The unit comes with two nozzles for CO2 output and one dual-nozzle fog output. When combining together, it can achieve that effect of a four-nozzle CO2 JET while consuming half amount of gas, making it cost-effective. Both CO2 output and Fog output can be controlled separately also, that means it can be used as fog machine or CO2 Jet. It is pretty suitable for the application of nightclubs, music festivals and event halls.

### 2.2 Features

- Hybrid two in one unit, fog machine + CO2 JET ;
- Gas saving with fog fluid being used to enhance output; Clear water level indicator;
- Massive output, creating extraordinary gas column effect;
- High quality durable magnetic valve;
- Stable and strong anti-interfere circuit design, stable and reliable;
- Please use DJPOWER fog fluid PRO-A or PRO-C.

Note: The actual effect may be affected by the using environment.

### 2.3 Product Overview

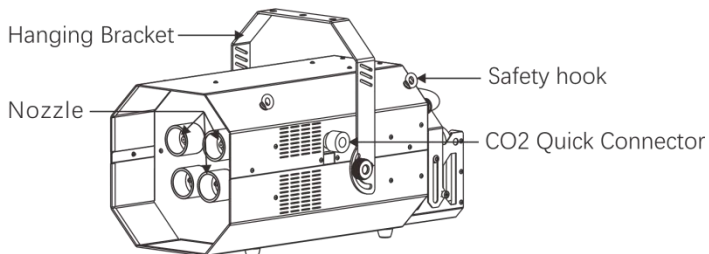

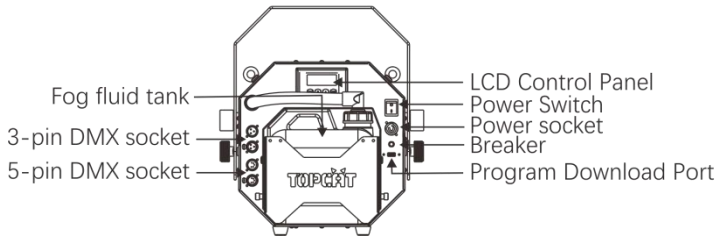

## 2.4 Product Dimensions

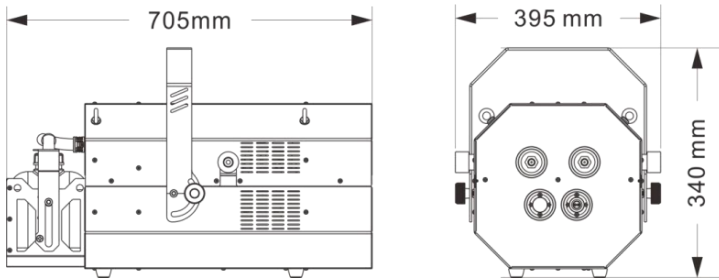

## 3 TECHNICAL SPECIFICATIONS

<b>AC Power</b>	Input Voltage & Rate	AC 220-240 V, 50/60 Hz
	Current Limiter Type	Breaker
	Current Limiter Specifications	15 A, 250 V
	Typical Operating Current (230V)	11.3 A
<b>Heating</b>	Nominal Total Power Consumption	2,500 W
	Heat Up Time	Appr. 8 min
<b>Capacity</b>	Fog Fluid Tank Capacity	5 L
	Fog Adjustable Output	×
<b>Output</b>	Max Output Distance	Appr. 12 m
	Max Output Volume	Appr. 78,000 cuft/min
	Maximum Continuous Duration	Appr.10 s
	Max Output Fluid Consumption	Appr. 2.6 min/L
	Consumables for Standard Output	CO <sub>2</sub> & PRO-V or PRO-D or PRO-A Fog Fluid
	<b>Accessories</b>	Hose
Flightcase		Optional
Power Cord		√
<b>Placement &amp; Mounting</b>	Flatwise	√
	Rigging & Trussing	√
<b>Control</b>	On-device Manual Control	LCD
	Control Protocol	DMX-512

	DMX Channel Range	3
	Net Weight	35 kg
<b>Weight &amp; Dimensions</b>	Gross Weight	41 kg
	Machine Dimensions	705 × 395 × 340 mm
	Packing Dimensions - Height	840 × 530 × 448 mm
<b>Consumable</b>	Consumable	CO2 & PRO-V or PRO-D or PRO-A Fog Fluid

## 4 SETUP

### 4.1 AC Power

The machine has two kinds of voltage power supply, it can work with an input voltage of AC 220 V-240 V, 50/60 Hz, depending on the specific model.

To determine the product's power requirements (circuit breaker, power outlet, and wiring), use the current value listed on the label affixed to the product's back panel, or refer to the product's specifications chart. The listed current rating indicates the product's average current draw under normal conditions.



**Always connect the product to a protected circuit (circuit breaker or fuse). Make sure the product has an appropriate electrical ground to avoid the risk of electrocution or fire.**



**Never connect the product to a rheostat (variable resistor) or dimmer circuit, even if the rheostat or dimmer channel serves only as a 0 to 100% switch.**

### 4.2 AC Plug

The X-7M Hybrid JET comes with a power input cord terminated with a Lockable power connector on one end. The other end is

- EU plug (EU market, etc.)
- US plug (US market, etc.)

If the power input cord that came with your product has no plug, or if you need the change the plug, use the table below to wire the new plug:

Connection	Wire (U.S.)	Wire (Europe)	Screw color
AC Live	Black	Brown	yellow or brass
AC Neutral	White	Blue	silver
AC Ground	Green/Yellow	Green/Yellow	green

### 4.3 DMX Linking

You can link the X-7M to a DMX controller using a 3- or 5-pin DMX connection. If using other DMX-compatible products with this product, you can control each individually with a single DMX controller. Instructions for connecting and configuring this product for DMX operation are in the User Manual.

### 4.4 Mounting

Before mounting the product, read and follow the safety recommendations indicated in the Safety Notes.

### 4.4.1 Orientation

For safety reasons, make sure the unit is well mounted through bracket and with safety cable. Also make sure there is adequate room for ventilation, configuration, and maintenance.

### 4.4.2 Rigging

- Make sure that the structure or surface onto which you are mounting the product can support the product's weight (see the Technical Specifications).
- When mounting the product on the floor, make sure that the product and cables are away from people and vehicles.

## 5 OPERATION

### 5.1 Preparing for Operation

- After checking that all the parts are intact and complete, position the machine on flat.
- Fill the DJPOWER fog fluid PRO-C into the fluid tank.
- The gas only can be CO2. Connect the CO2 gas cylinder and the unit through hose and connectors. Ensure there is no gas leakage before using.
- Always connect the product to a grounded circuit. Before power on, make sure it is connected with the rated voltage.
- Turn on the machine, it will immediately start heating up for the fog machine system.
- During the heating process, CO2 output can be controlled separately once the machine is powered on.

### 5.2 On-device Control Mode & Operation

To access the control panel functions, use the four buttons located underneath the LCD display.

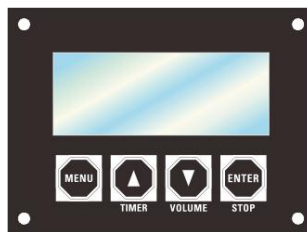

<MENU>	Switch menu pages to select a function
▲/<TIMER>	Increases the numeric value of current function Trigger TMER output mode
▼/<VOLUME>	Decreases the numeric value of current function Trigger Manual output mode
<ENTER> /<STOP>	Save settings STOP turns the fog output off



## 5.2.1 Menu Map

	Display	Description	Parameter Range
	Heating Up >>>>>>>>	The machine is heating up.	
	Ready To Work X-7M	Finished heating up, ready to work.	
	Timer Interval 10S	Press "▲" or "▼" button to set interval under TIMER mode.	1-200S
	Timer Duration 10S	Press "▲" or "▼" button to set duration under TIMER mode.	1-10S
Preparin g Page		Press "▼"/ <TIMER> to enter into TIMER Mode. The relevant pages are explained as below: ① "Interval 10S": Interval countdown of TIMER mode ② "Duration 10S": Duration countdown of TIMER mode Under TIMER Mode, the fog output is set through <VOLUME> between 10% and 100%.	
	Smoke-free detection ON	press "▲" and "▼" to set the smoke-free ON and OFF	ON/OFF
	DMX Address 1	Press "▲" or "▼" button to set DMX starting address.	1 - 512
	Language English	Press "▲" or "▼" to select the language and save by ENTER	Chinese/English
Working Status Page	Volume 100%	Press "▼"/ <VOLUME> to start the continuous setting. Press "▲" or "▼" button to set the volume between 10% and 100%.	10% -100%
		Press <ENTER> / <STOP> at any time to return to the standby page.	

## 5.3 DMX Mode & Operation

X-7M Hybrid JET works with a DMX controller.

- Connect the product to a suitable power outlet.
- Turn the product on.

- Connect a DMX cable from the DMX output of the DMX controller to the DMX input socket on the product.

### 5.3.1 DMX Working Page

---

DMX Address
1

Pressing “▲” or “▼” to set the DMX starting address 1 - 512

---

Standby and setup page

 **When setting the DMX starting address, the number of channels occupied by the DMX mode must be considered. If the starting address is too high, some channels may not be controlled.**

**In DMX mode, each machine responds to the control of the DMX controller through its own unique starting address. Machines with the same starting address will be synchronized accordingly.**

 **When connected with DMX controller and receiving DMX signal, the LCD display will always show current DMX starting address which can be reset by pressing “▲” or “▼”.**

---

### 5.3.2 DMX Channel Assignments and Values

X-7M has 3 DMX channels and can be connected by 3-pin or 5-pin DMX sockets. Set the DMX start address within the range of 001-512, you can independently control 512pcs devices with one DMX channel.

Channel	Function	Value	Description
1	Safety Channel	0-99	OFF
		100-155	ON
		156-255	OFF
2	Fog Output	0-9	OFF
		10-255	ON
3	CO2 Output	0-9	OFF
		10-255	ON

- Only when channel 1 is set to ON, channel 2 and channel 3 can work. Or set channel 2 and 3 in advance, use channel 1 as the master control.
- Both Channel 2 and Channel 3 can work independently so that that unit can be a fog machine or a CO2 JET.
- When both channel 2 and channel 3 are set to ON, the CO2 output is determined by the fog output. That is, CO2 output ON/OFF corresponds with the Fog output ON/OFF. When the fog output stops, the CO2 output also stops. This ensures the mixed effect of fog and CO2.
- When channel 2 is set to the OFF state and channel 1 is set to the ON state, the carbon dioxide output is controlled by channel 3.

## 5.4 Fluid Sensor

This machine uses physical sensor to detect whether there is fluid inside tube so as to protect the pump from being damaged.

Turn on the “Fluid Sensor” to activate “No Fluid Protection” function.

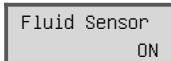

## 5.5 Trigger “No-Fluid Protection”

When the Fluid Sensor is ON, the physical sensor based “no-fluid protection” function will be activated. After the program continues to detect the machine working with no fluid inside the tube for 60 s, the pump-shutoff will be activated with the flickering warning page showing on the screen.

## 5.6 Clear “No-Fluid Protection” Warning

When the machine is under the no-fluid protection, after refilling the fluid, there are three ways to clear the warning.

- Press<ENTER> first, then press<VOLUME> to let the machine run again, the warning will disappear until the fluid is pumped and fill the tube.
- Under the DMX control mode, slide down channel 1 to OFF, then back to ON, to let the machine run again. The warning will disappear until the fluid is pumped and fill the tube.
- Turn off “Fluid Sensor” in the menu.

# 6 TECHNICAL INFORMATION

## 6.1 Maintenance

X-7M Hybrid JET needs regular maintenance to achieve the best performance. However, in order to achieve the best results, some cleaning and maintenance steps are essential:

- Regularly clean each air inlet and air outlet to prevent sand and dust from clogging, so as to extend the service life.
- The maximum service life of the carbon dioxide connecting hose is 1 year, and a new one needs to be replaced after 1 year.
- The filter needs to be cleaned every 3 months. Please remove the filter element to clean it. After cleaning, put it back in place and tighten it tightly. Do not install it in the reverse direction.

## 6.2 Storage

Before storing the machine, clean it and empty the fluid tank.

